

Quick manual

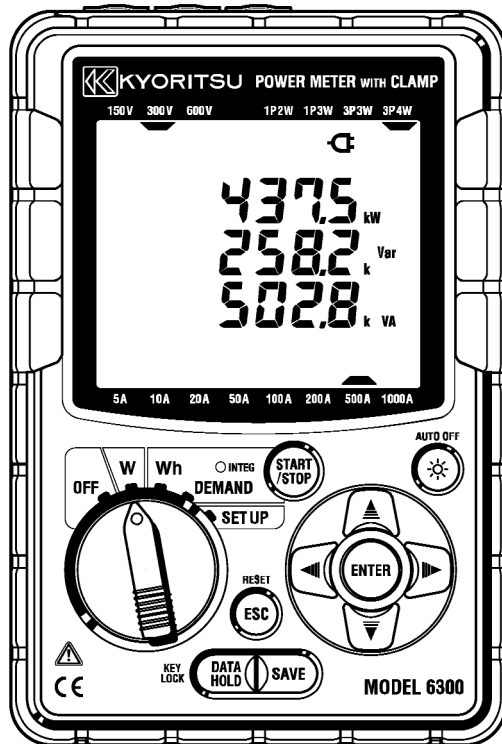

DIGITAL POWER METER

MODEL 6300



KYORITSU ELECTRICAL INSTRUMENTS
WORKS, LTD.

- Preface

This Quick manual is a simplified version of the full instruction manual which can be found in the supplied CD-ROM.

This manual is intended only as a handy reference guide and should only be used after having read the full instruction manual which contains full details on each function of this instrument and the items contained in the package.

- Safety Warning!

The instruction manual contains warnings and safety procedures which have to be observed to ensure safe operation of the instrument and maintain it in a safe condition. Thus, these operating instructions have to be read prior to using the instrument.

Contents

1. Functional overview	2
2. Instrument layout	3
3. Setting: SET UP range	5
4. Wiring	8
5. Instantaneous value measurement: W range	9
6. Integration value measurement: Wh range	13
7. Demand value measurement: DEMAND range	16
8. CF card/ Save data	19

Each section heading in this manual is followed by a cross reference (enclosed in parenthesis) to the Instruction manual. The subheadings are also followed by a similar cross reference which refers to the corresponding clause in the instruction manual.

The contents of this Quick manual are subject to change without prior notice.

1. Functional overview (Section 1)

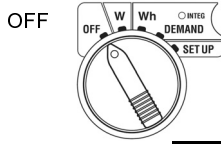

ON: (Section 3)
 * AC power supply
 * Battery

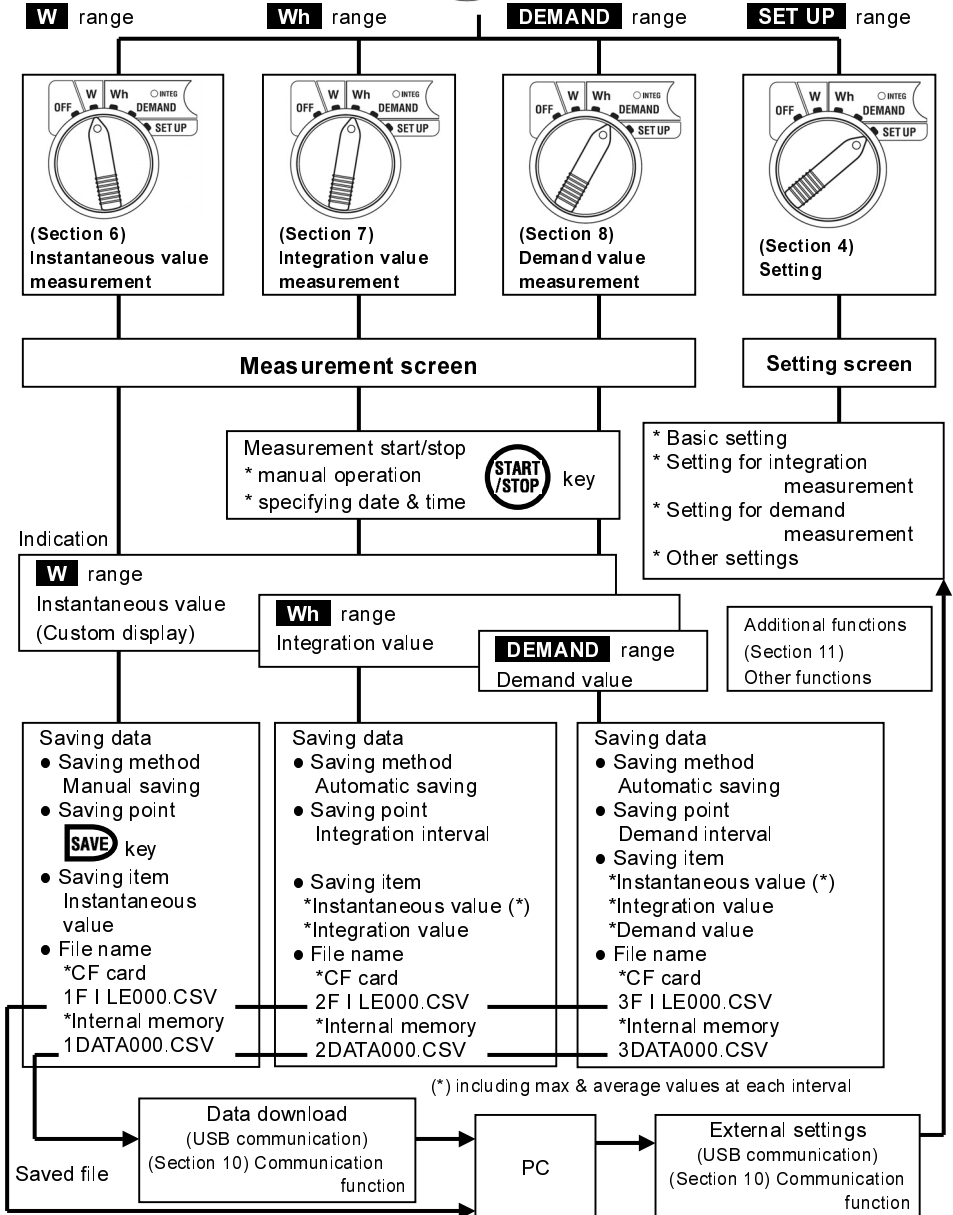

2. Instrument layout (Section 2)

- Display & keys (2-1)

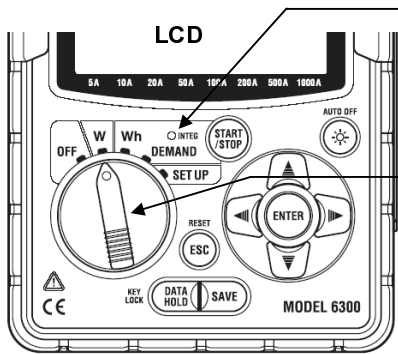

LED status indicator

- *Lights up: During integration/ demand measurement
- *Flashes : During integration/ demand stand-by mode

Function switch

- * Turns the instrument on when it is in any position other than OFF. (Section 3)

 1. AC power supply, or
 2. Battery

Keys	Details	Keys	Details
	Starts/ Stops integration and demand measurement.		* Cancels a setting * Clears integration/ demand value
	Switches on/off the backlight of the LCD.		* Data hold * Key lock Pressing this key for at least 2 sec locks keys. Pressing again this key for at least 2 sec releases key lock.
	Measurement screen: Switches the display contents. Setting screen: Changes selection, number, or moves digits.		
	Confirms entry such as a change to a setting.		Saves the instantaneous measurement data.

- Connector (2-2)

Voltage input terminal
(VN, V1, V2, V3)

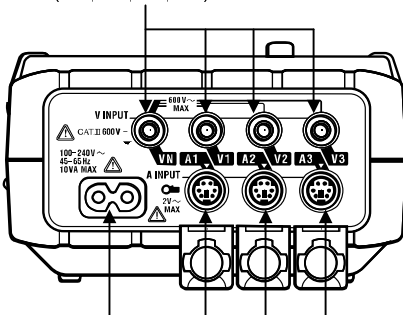

Power supply connector

Current input terminal
(A1, A2, A3)

- CF card/ USB part (2-3)

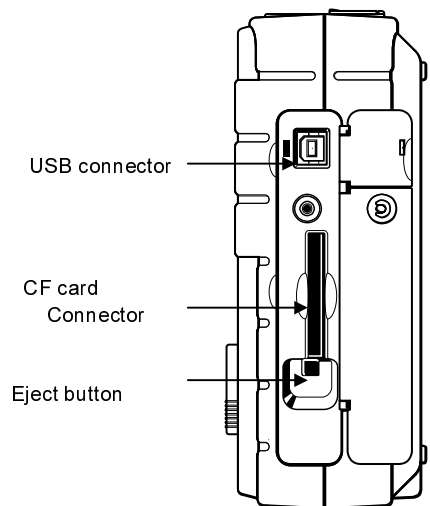

USB connector

CF card
Connector

Eject button

- Marks displayed on the LCD (2-1)
< All marks to be displayed on the LCD >

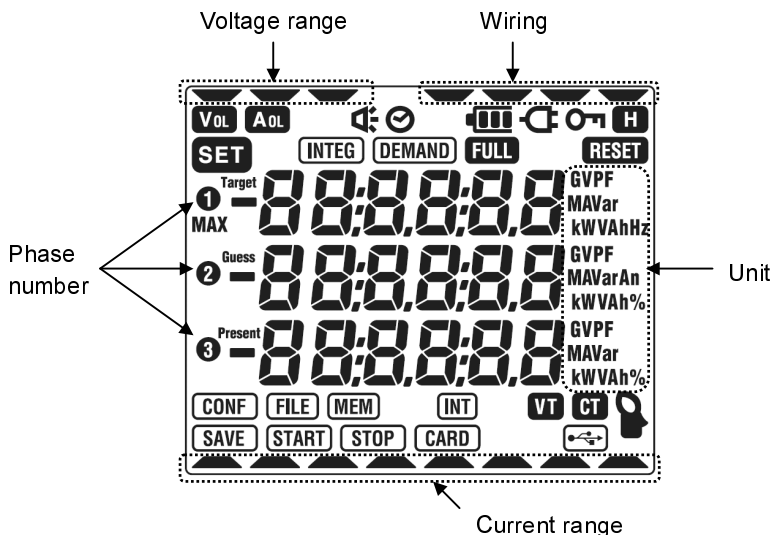





< Marks indicate the measurement status or functions >

Mark	Measurement status or function
	Displayed when the keys are locked.
	Displayed when voltage exceeds a certain value.
	Displayed when current exceeds a certain value.
	Displayed when instrument is operating with AC power supply.
	Displayed when instrument if operating with batteries.
	Displayed when data hold function is activated.
	Displayed during integration, Flashes during stand-by mode.
	Displayed during demand, Flashes during stand-by mode.
	Displayed when the capacity of CF card or internal memory is full.
	Displayed while saving data in CF card.
	Displayed when opening/ closing a file at measurement.
	Displayed when saving data.
	Displayed when a file exists in the internal memory.
	Displayed when VT ratio is set to at a value other than 1.
	Displayed when CT ratio is set to at a value other than 1.

3. Setting: **SET UP** range (Section 4)

3.1 List of setting items (4-1)

Each Setting	Item No./ Setting item	Mark	Setting
Basic setting	01 Wiring	-	1P2W(1ch)/ 1P2W(2ch)/ 1P2W(3ch)/ 1P3W/ 3P3W /3P4W
	02 Voltage range	-	150/ 300/ 600V
	03 Current range	-	Range (04 Clamp sensor) 5/ 10/ 20/ 50A : (50A) 10/ 20/ 50/ 100A : (100A) 20/ 50/ 100/ 200A : (200A) 50/ 100/ 200/ 500A : (500A) 100/ 200/ 500/ 1000A : (1000A) 1000/ 3000A : (3000A)
	04 Clamp sensor		50/ 100/ 200/ 500/ 1000/ 3000A
	05 VT ratio	VT	1 ~ 10000
	06 CT ratio	CT	1.00 ~ 10000.0
	Other settings	07 Time (*1)	
08 Buzzer			on (sound) oFF (not sound)
Settings only for integration measurement	09 Integration interval	INTEG INT	1/ 2/ 5/ 10/ 15/ 20/ 30 sec. 1/ 2/ 5/ 10/ 15/ 20/ 30 min., 1 hour
	10 Integration start time & date	INTEG START	Year : Month : Day, Hour : Minute : Second
	11 Integration stop time & date	INTEG STOP	Year : Month : Day, Hour : Minute : Second
	12 Reset of integration value	INTEG RESET	on (reset) oFF (not reset)
Settings only for demand measurement	13 Demand Interval	DEMAND INT	1/ 2/ 5/ 10/ 15/ 20/ 30 sec. 1/ 2/ 5/ 10/ 15/ 20/ 30 min., 1 hour
	14 Demand start time & date	DEMAND START	Year : Month : Day, Hour : Minute : Second
	15 Demand stop time & date	DEMAND STOP	Year : Month : Day, Hour : Minute : Second
	16 Demand target value	DEMAND Target	0.1W ~ 999.9GW
	17 Demand inspection cycle	DEMAND 	Can select a time from any three of preceding time as demand interval. <e.g.> Interval =30min. →10/ 15/ 20 min.
	18 Reset of demand value	DEMAND RESET	on (reset) oFF (not reset)

Each Setting	Item No./ Setting item	Mark	Setting
Setting for CF card	19 Use of CF card (*2)	CARD	on (use) oFF (not use, use internal memory)
	20 Formatting of CF card		on (formatting) oFF (not formatting)
	21 Deleting the data in CF card		dEL (delete) not.dEL (not delete)
Other settings	22 Deleting the data in internal memory	MEM	dEL (delete) not.dEL (not delete)
	23 System reset	RESET	on (reset) oFF (not reset)
	24 Loading settings	CONF	Save number 01 ~ 20
	25 Saving settings		Save number 01 ~ 20

(*1) Time has been adjusted to Japanese local time at the shipment.

(*2) CF card is automatically identified when turning on the instrument.

3-2 Setting procedure (4-3)

STEP 1 Set the Function switch to **SET UP** range. (setting screen)

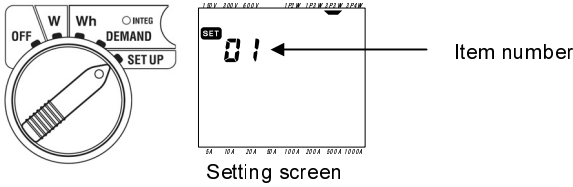

STEP 2 Switch the setting items (Item number 01 ~ 25) with keys.

STEP 3 Press the key on the selected item.
(Then settings blink and the instrument gets setting change mode.)

STEP 4 Change the settings with keys.

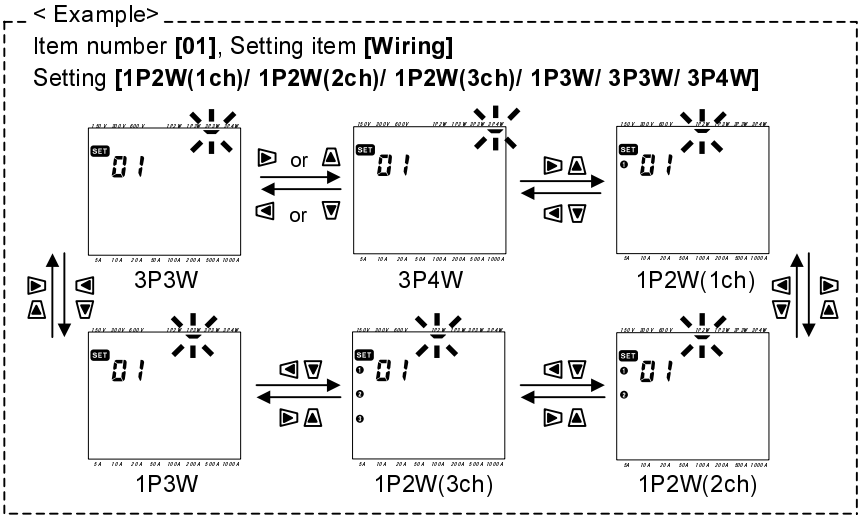

STEP 5 Enter the settings.
(Press the key.)

STEP 5 Cancel the settings.
(Press the key.)

Setting ends: Proceed to **STEP2** to do other settings.

4. Wiring (Section 5)

• Single-phase 2-wire (1ch) "1P2W (1ch)"

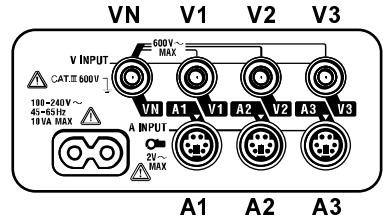
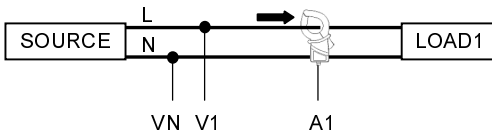

• Single-phase 2-wire (2ch) "1P2W (2ch)"

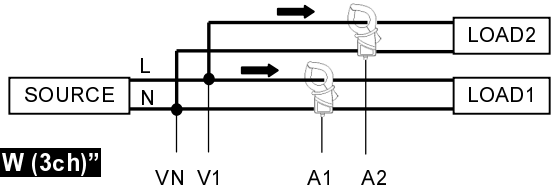

• Single-phase 2-wire (3ch) "1P2W (3ch)"

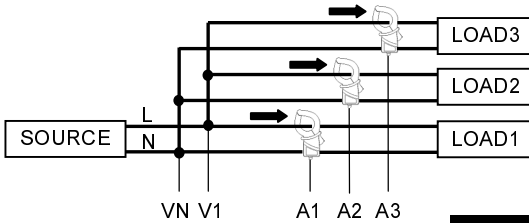

• Single-phase 3-wire "1P3W"

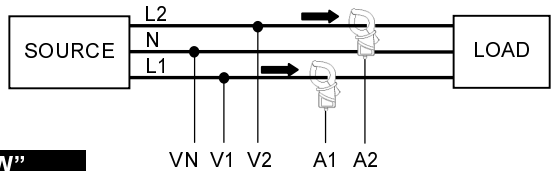

• Three-phase 3-wire "3P3W"

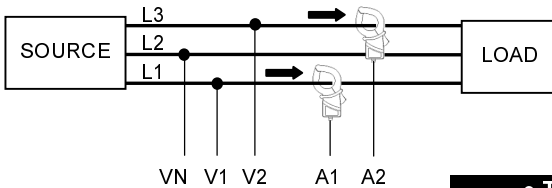

• Three-phase 4-wire "3P4W"

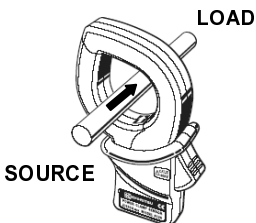
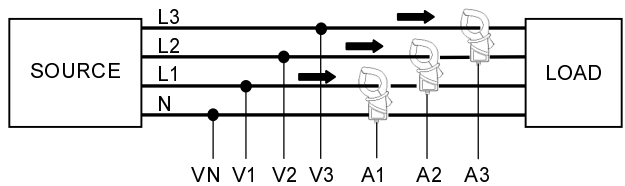

5. Instantaneous value measurement: **W** range (Section 6)

- Measurement flow chart

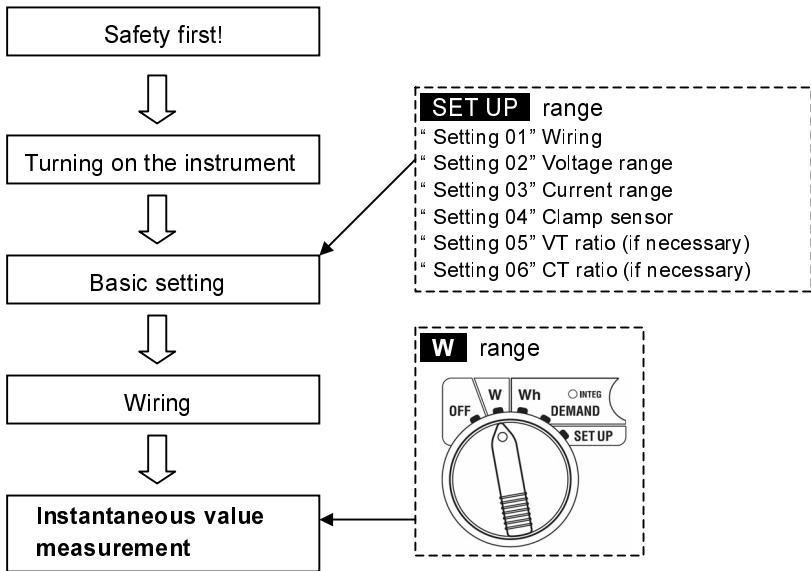

- Displayed items on **W** range

Displayed parameters			Unit
Voltage (RMS)	V : Average voltage of V_i	V_{i1} : Voltage per phase	V
Current (RMS)	A : Average current of V_i	A_{i1} : Current per phase	A
Active power	P : Total active power Polarity: + (no mark) consumption, - (minus) regenerating	P_{i1} : Active power per phase	W
Reactive power	Q : Total reactive power Polarity: + (no mark) phase lag, - (minus) phase lead	Q_{i1} : Reactive power per phase	Var
Apparent power	S : Total apparent power	S_{i1} : Apparent power per phase	VA
Power factor	PF: Total power factor Polarity: + (no mark) phase lag, - (minus) phase lead	Pf_{i1} : Power factor per phase	PF
Frequency	f : Frequency at V_1		Hz
Neutral current	I_n : Current on a neutral line (only at three-phase 4-wire)		A_n

* i = 1, 2, 3

●other wiring configuration

Display screen can be switched in the same way to switch "3P4W".

Wiring	A	B	C	D	E	F	G
1P2W (1ch) 9 screens	V A P	-	-	-	-	-	-
	P S PF	-	-	-	-	-	-
	V - -	A - -	P - -	PF - -	S - -	Q - -	f - -
1P2W (2ch) 13 screens	V A P	V A1 P1	V A2 P2	-	-	-	-
	P S PF	P1 S1 PF1	P2 S2 PF2	-	-	-	-
	V - -	A1 A2 -	P1 P2 -	PF1 PF2 -	S1 S2 -	Q1 Q2 -	f - -
1P2W (3ch) 15 screens	V A P	V A1 P1	V A2 P2	V A3 P3	-	-	-
	P S PF	P1 S1 PF1	P2 S2 PF2	P3 S3 PF3	-	-	-
	V - -	A1 A2 A3	P1 P2 P3	PF1 PF2 PF3	S1 S2 S3	Q1 Q2 Q3	f - -
1P3W 13 screens	V A P	V1 A1 P1	V2 A2 P2	-	-	-	-
	P S PF	P1 S1 PF1	P2 S2 PF2	-	-	-	-
	V1 V2 -	A1 A2 -	P1 P2 -	PF1 PF2 -	S1 S2 -	Q1 Q2 -	f - -
3P3W 13 screens	V A P	V1 A1 P1	V2 A2 P2	-	-	-	-
	P S PF	P1 S1 PF1	P2 S2 PF2	-	-	-	-
	V1 V2 -	A1 A2 -	P1 P2 -	PF1 PF2 -	S1 S2 -	Q1 Q2 -	f - -

5.2 Data saving procedure (6-4)

The instantaneous value (on **W** range) can be saved only by a manual operation.

Opening a file

Pressing the **SAVE** key on **W** range during a measurement displays File number screen and file is opened. (First data is recorded at this stage.)

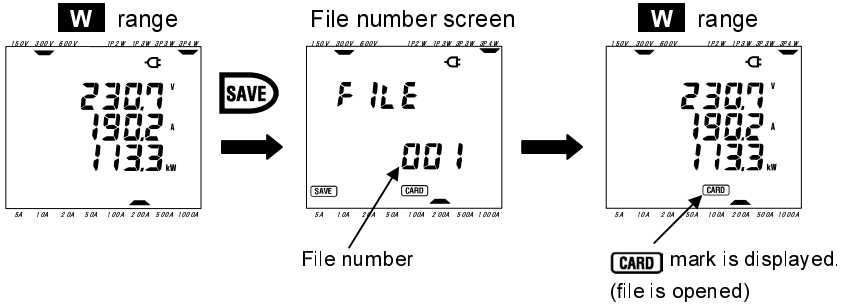

Pressing the **SAVE** key again records next (second) data stream.

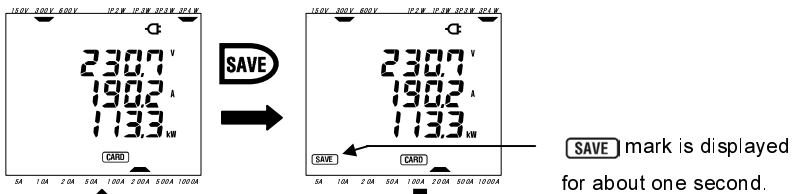

Closing a file

Set the Function switch to any position **other than W and OFF**.

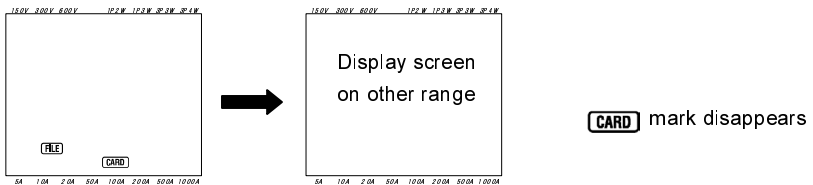

Completing Data saving Procedure

According to above procedure, data can be saved to one file whenever the **SAVE** key is pressed.

- * When data is saved to the internal memory, the **MEM** mark is displayed instead of the **CARD** mark.
- * File shall be closed first. Data will not be saved when a file is not closed.
- * File has to be closed ! Data will not be saved unless a file is closed.

6. Integration value measurement: **Wh** range (Section 7)

- Measurement flow chart

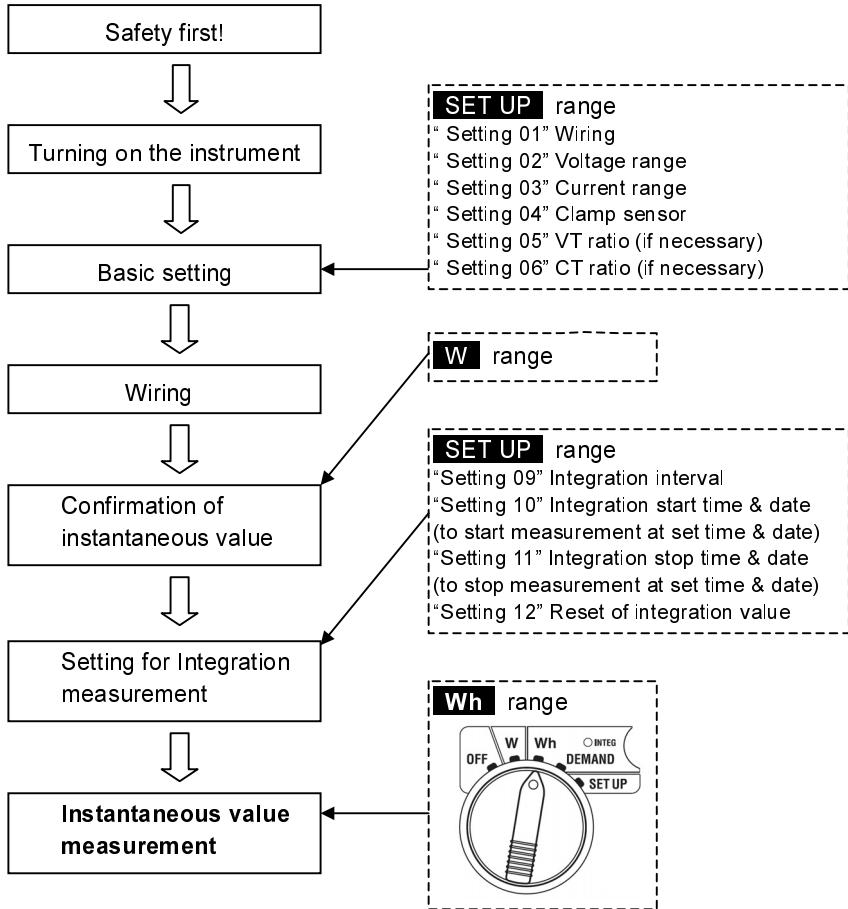

- Items displayed on **Wh** range

Displayed parameters		Unit
Active electrical energy (consumption)	WP	: Total active electrical energy
	WP1/WP2/WP3	: Active electrical energy per phase
Apparent electrical energy (consumption)	WS	: Total apparent electrical energy
	WS1/WS2/WS3	: Apparent electrical energy per phase
Elapsed time of integration	TIME	: Hour; Min.; Sec.
		: Hour; Min. Hour

6.1 Measurement execution (7-1, 7-2)

●Manual mode

Press the **START/STOP** key.
(at least for 2 sec.)

Wh range

●Automatic mode (setting the date and time)

Make setting at Setting 10 & 11
Press the **START/STOP** key.



File number screen is displayed for about 2sec. (**open a file**)
* Start measurement manually.
* When automatic measurement is set, the instrument goes into stand-by mode and measurement starts at the set time & date. In stand-by mode, both LED status indicator and the **INTEG** mark flash. Both indicators are displayed when measurement starts.

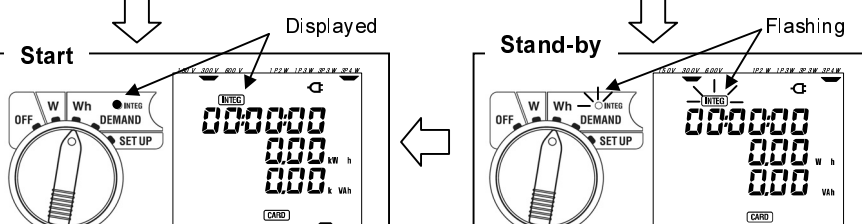

Start → **Stand-by**

Displayed → Flashing

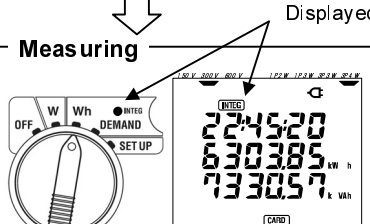

Measuring

Displayed

- * Indicated value is refreshed every 1 sec.
- * Data is saved at the interval, which is pre set at "Setting 09".
- * During a measurement, instantaneous value can be viewed on **W** range and settings can be viewed on **SET UP** range.

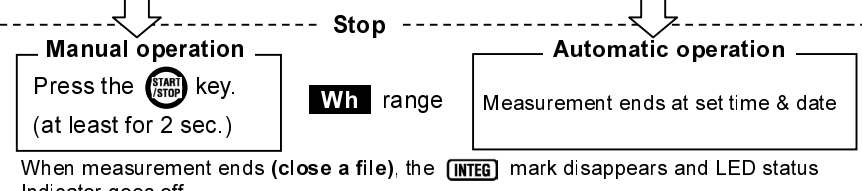

Stop

Manual operation → **Automatic operation**

Press the **START/STOP** key.
(at least for 2 sec.)

Wh range

Measurement ends at set time & date

When measurement ends (**close a file**), the **INTEG** mark disappears and LED status Indicator goes off.

* In case the data to be saved to the internal memory, the **MEM** mark is displayed instead of the **CARD** mark.

* Ensure that the file is closed. Data will not be saved unless a file is closed.

Following a measurement, integration value is still shown on the display screen.

When the value is not requires for the subsequent measurement, reset (7-3) the integration value by pressing the **ESC** key for at least 2 sec. and select "dEL", or at "Setting 12".

6.2 Display screen / Data capturing (7-4, 7-5)

- Display screen modes

< For Three-phase 4-wire “3P4W” configuration >

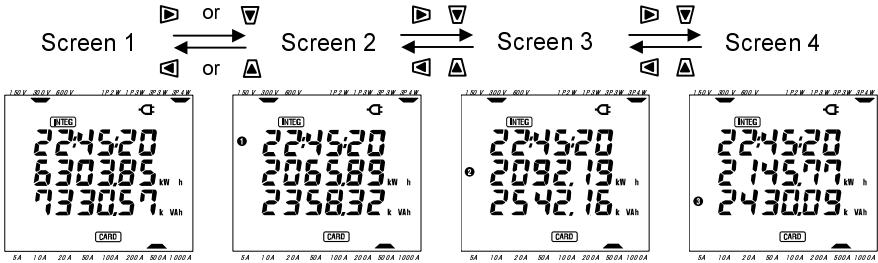

<Other wiring configurations>

Wiring("Setting 01")	Displayed at	Displayed contents			
		Screen1	Screen2	Screen3	Screen4
1P2W (1ch)	Upper Middle Lower	TIME WP WS	-	-	-
1P2W (2ch) 1P3W 3P3W	Upper Middle Lower	TIME WP WS	TIME WP1 WS1	TIME WP2 WS2	-
1P2W (3ch) 3P4W	Upper Middle Lower	TIME WP WS	TIME WP1 WS1	TIME WP2 WS2	TIME WP3 WS3

- Saving capturing (Data is saved automatically without user intervention.)

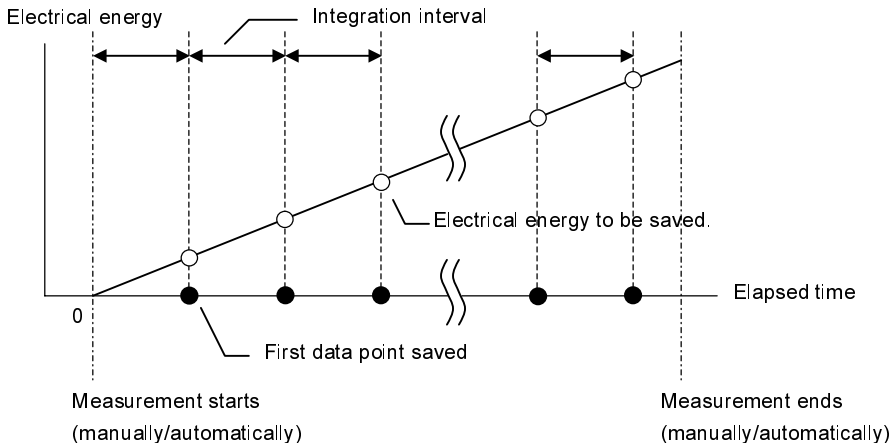

7. Demand value measurement: **DEMAND** range (Section 8)

- Measurement flow chart

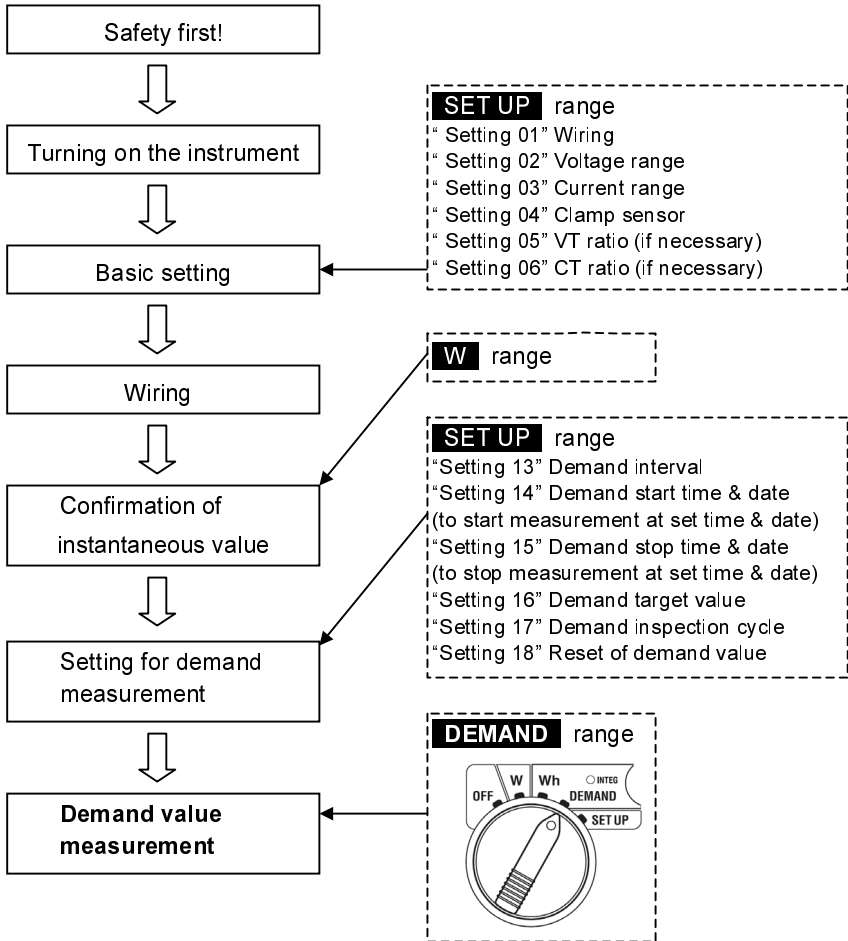

- Displayed items on **DEMAND** range

Displayed parameters	Unit
Target value	W
Predicted value	W
Present value	W
Load factor	%
Remaining time	-
Max. demand value	W
Date and time when max. demand value measured	-

7.1 Measurement execution (8-3, 8-4)

●Manual mode

Press the **START/STOP** key.
(at least for 2 sec.)

DEMAND
range

●Automatic mode (setting the date and time)

Make setting at Setting 14 & 15
Press the **START/STOP** key.

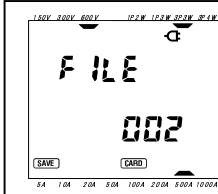

File number screen is displayed for about 2sec. (**open a file**)

* Start measurement manually.

* When automatic measurement is set, the instrument goes into stand-by mode and measurement starts at the set time & date. In stand-by mode, LED status indicator and the **DEMAND** mark flash. Both are displayed when measurement starts.

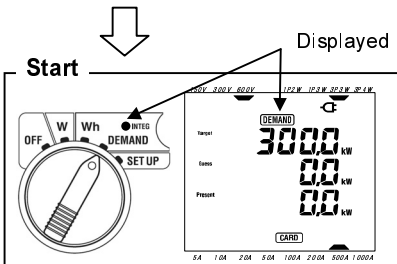

Displayed

Start

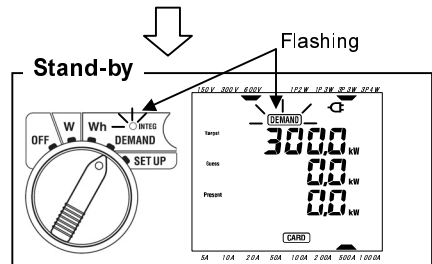

Flashing

Stand-by

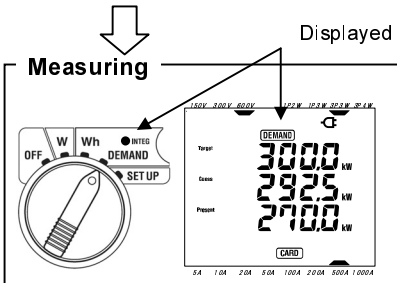

Displayed

Measuring

- * Indicated value is refreshed every 1 sec.
- * Data is saved at the interval, which is pre set at "Setting 13".
- * During a measurement, instantaneous value can be viewed on **W** range, integration value on **Wh** range and settings can be viewed on **SET UP** range.

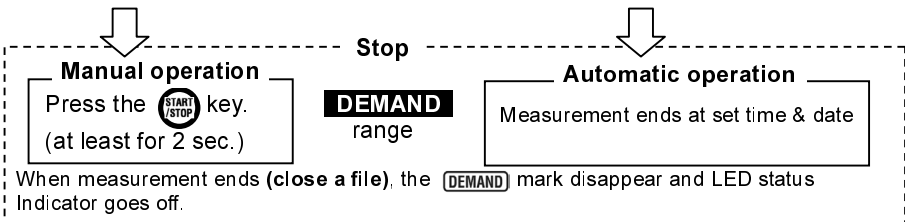

* In case the data to be saved to the internal memory, the **MEM** mark is displayed instead of the **CARD** mark.

* Ensure that the file is closed. Data will not be saved unless a file is closed.

After a measurement, demand value is kept indicated on the display screen.

Demand value is reset (8-5) by pressing the **ESC** key for at least 2 sec. and select "dEL", or at "Setting 18".

7.2 Display screen / Data capturing

- Display screen modes

Three display screens are common to each wiring configuration, and can be activated as follows.

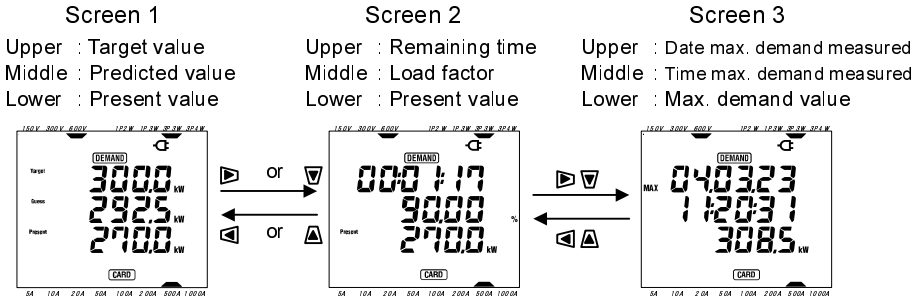

- Data capturing (Data is saved automatically without user intervention.)

< Operation in the demand interval of this instrument >

(W)

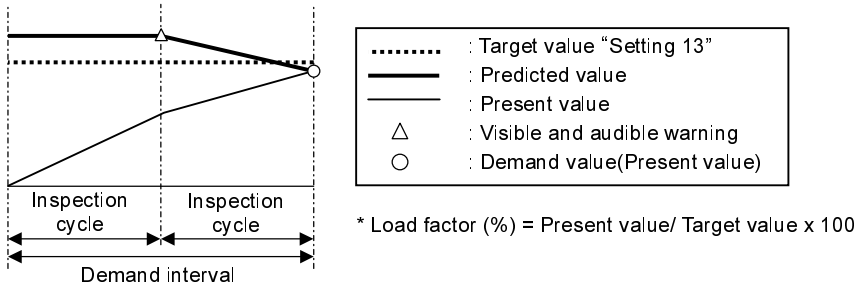

< Max. demand value and data saving point >

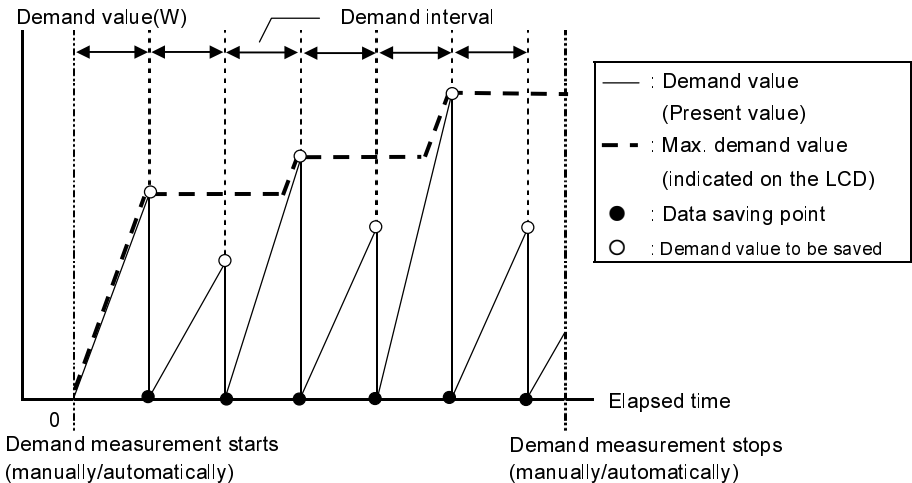

8. CF card (Section 9)/ Data saving (6-4, 7-5, 8-6)

- CF card

* Available capacity

32M/ 64M/ 128MB

(CF card with above stated capacity can be used.)

- * CF card

(Proper operation of following CF cards has been verified on this instrument.)

Supplier	Model	Capacity
SanDisk Corporation	SDCFB-32	32MB
	SDCFB-64	64MB
	SDCFB-128	128MB
Renesas Technology Corporation	HB28B128C8C	128MB
Adtec co., Ltd.	AD-CFG32	32MB
BUFFALO Inc.	RCF-X32MY	32MB
	RCF-X64MY	64MB
	RCF-X128MY	128MB

* Company name and model name are the trademark or the registered trademark.

- Max recordable number of data points (specification)

Data saved in:	CF card			Internal memory	
	32MB	64MB	128MB	128kB	
Capacity	32MB	64MB	128MB	128kB	
Instantaneous measurement	100,000 points	200,000 points	400,000 points	1,000 points	
Integration/ demand interval	1sec	7 hours	14 hours	28 hours	4 minutes
	1min	18 days	36 days	72 days	4 hours
	30min	1 year or more			5 days
File can be saved up to:	20 files			1 file	

* In case that no file exists in the CF card.

- File format and name

Measured data is saved in CSV format, and the file name is allocated automatically.

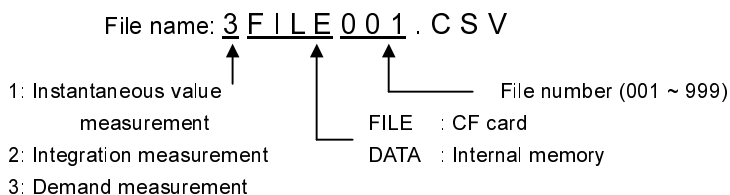

- Selection of parameters for recording

According to each measurement range, the following parameters are selected depending on each wiring configuration.

Manual saving on **W** range : Only the parameters listed in ① (except for each max/ avg)

Automatic saving on **Wh** range : parameters listed in ① and ②

Automatic saving on **DEMAND** range : parameters listed in ①, ② and ③

Parameters recorded			
①	Voltage (RMS)	V : Average voltage of Vi V max : Max. value of V V avg : Average value of V	Vi : Voltage per phase Vi max : Each max. value of Vi Vi avg : Each average value of Vi
	Current (RMS)	A : Average current of Vi A max : Max. value of A A avg : Average value of A	Ai : Current per phase Ai max : Each max. value of Ai Ai avg : Each average value of Ai
	Active power	P : Total active power P max : Max. value of P P avg : Average value of P	Pi : Active power per phase Pi max : Each max. value of Pi Pi avg : Each average value of Pi
	Reactive power	Q : Total reactive power Q max : Max. value of Q Q avg : Average value of Q	Qi : Reactive power per phase Qi max : Each max. value of Qi Qi avg : Each average value of Qi
	Apparent power	S : Total apparent power S max : Max. value of S S avg : Average value of S	Si : Apparent power per phase Si max : Each max. value of Si Si avg : Each average value of Si
	Power factor	PF : Total power factor PF max : Max. value of PF PF avg : Average value of PF	Pfi : Power factor per phase Pfi max : Each max. value of Pfi Pfi avg : Each average value of Pfi
	Frequency	f : Frequency of V1 f max : Max. value of f f avg : Average value of f	Neutral current In : Neutral current In max : Max. value of In In avg : Average value of In
②	Active electrical energy (consumption) (regenerating) (overall)	+WP : Total active electrical energy (consumption) +WPi : Active electrical energy per phase (consumption) -WP : Total active electrical energy (regenerating) -WPi : Active electrical energy per phase (regenerating) #WP : Total active electrical energy (overall) #WPi : Active electrical energy per phase (overall)	
	Apparent electrical energy (consumption) (regenerating) (overall)	+WS : Total apparent electrical energy (consumption) +WSi : Apparent electrical energy per phase (consumption) -WS : Total apparent electrical energy (regenerating) -WSi : Apparent electrical energy per phase (regenerating) #WS : Total apparent electrical energy (overall) #WSi : Apparent electrical energy per phase (overall)	
	Reactive electrical energy (consumption)	+WQ : Total reactive electrical energy (consumption)	
③	Demand value	#DEM : Total demand value TARGET : Target value	#DEMi : Demand value per phase

* i = 1, 2, 3

“max” and “avg” mean maximum value and average value during an interval.

MEMO

MEMO

DISTRIBUTOR

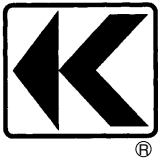

KYORITSU ELECTRICAL INSTRUMENTS WORKS, LTD.

No.5-20, Nakane 2-chome, Meguro-ku,
Tokyo, 152-0031 Japan

Phone : 81-3-3723-0131 Fax : 81-3-3723-0152

URL : <http://www.kew-ltd.co.jp>

E-mail : info@kew-ltd.co.jp

Factories : Uwajima & Ehime